

06/12/2017

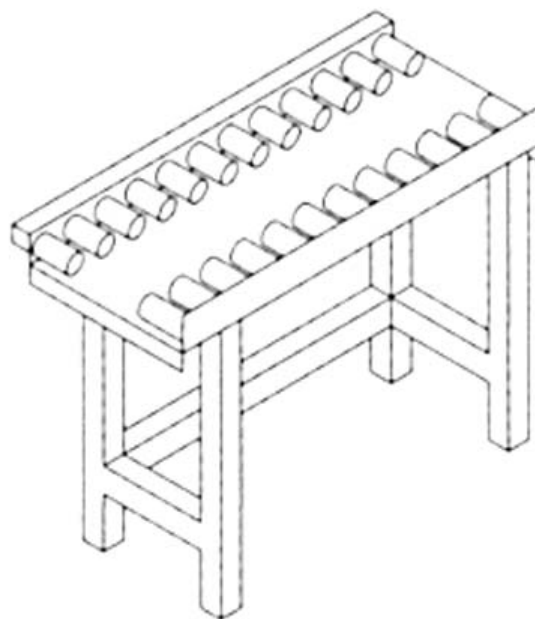

NIF: 512016038

Rua da Alegria, n.º 87/91, S. José
9500-157 PONTA DELGADA
Telf: 296 285 922 | Fax: 296281785
Email: geral@acorotel.com



MOA005822

Ref. 0890.35.013

Tapete de rolos com pio, LPA 1600x650x880 mm